

TR4110IBL2

Cooker size	110x60 cm
N. of cavities with energy label	2
Cavity heat source	Electric
Hob type	Induction
Type of main oven	Thermo-ventilated
Type of second oven	Fan assisted
Cleaning system main oven	Vapor Clean
EAN code	8017709312435
Energy efficiency class	A
Energy efficiency class, second cavity	A



Aesthetics

Aesthetics	Victoria	Colour of buttons	Black
Colour	Black	No. of controls	10
Design	Victoria	Serigraphy colour	Silver
Door	With frame	Handle	Smeg Victoria
Upstand	Yes	Handle Colour	Brushed stainless steel
Hob colour	Black enamel	Glass type	Black
Command panel finish	Enamelled metal	Plinth	Anthracite
Control knobs	Smeg Victoria	Storage compartment	Drawer
Controls colour	Stainless steel	Logo	assembled 50's
Display	electronic 5 buttons	Logo position	Upstand

Programs / Functions

No. of cooking functions 5

Traditional cooking functions



Static



Fan assisted



Circulaire



ECO



Fan assisted base

Cleaning functions



Vapor Clean

Other functions



Defrost by time

Programs / Functions Auxiliary Oven

Cooking functions cavity 2 6

Traditional cooking functions, cavity 2



Static



Fan assisted



ECO



Large grill



Fan grill (large)



Fan-assisted bottom

Programme / Functions Third Oven

No. of functions third oven

1

Oven light



Full grill



Hob technical features



Total no. of cook zones 5

Front left - Induction - single - 2.3 kW - Booster 3 kW - - Ø 21.0 cm

Rear left - Induction - single - 1.3 kW - Booster 1.4 kW - - Ø 18.0 cm

Central - Induction - single - 2.3 kW - Booster 3 kW - - Ø 27.0 cm

Rear right - Induction - single - 1.3 kW - Booster 1.4 kW - - Ø 18.0 cm

Front right - Induction - single - 2.3 kW - Booster 3 kW - - Ø 21.0 cm

Automatic switch off when overheat Yes

Minimum pan diameter indication Yes

Automatic pan detection Yes

Selected zone indicator Yes

Main Oven Technical Features



No. of lights 1

Fan number 1

Net volume of the cavity 61 litres

Gross volume, 1st cavity 70 l

Cavity material Easy clean enamel

Shelf positions 4

Type of shelves Metal racks

Light type Halogen

Light power 40 W

Cooking time setting Start and Stop

Door opening Side opening

Removable inner door Yes

Total no. of door glasses 3

No. of thermo-reflective door glasses 1

Safety Thermostat Yes

Cooling system Tangential

Usable cavity space dimensions (HxWxD) 316x460x412 mm

Temperature control Electro-mechanical

Lower heating element power 1200 W

Side opening door	Yes	Upper heating element - Power	1000 W
Removable door	Yes	Grill element	1700 W
Full glass inner door	Yes	Large grill - Power	2700 W
		Circular heating element - Power	2700 W
		Grill type	Electric

Options Main Oven

Timer	Yes	Minimum Temperature	50 °C
End of cooking acoustic alarm	Yes	Maximum temperature	260 °C

Second Oven Technical Features



Fan number	1	Removable inner door	Yes
Net volume of the second cavity	61 litres	No. total door glasses	3
Gross volume, 2nd cavity	70 l	No. thermo-reflective door glasses	1
Cavity material	Easy clean enamel	Safety Thermostat	Yes
Shelf positions	4	Cooling system	Tangential
Type of shelves	Metal racks	Usable cavity space dimensions (HxWxD)	316x444x425 mm
No. of lights	1	Temperature control	Electro-mechanical
Light type	Halogen	Lower heating element - power	1200 W
Light power	40 W	Upper heating element - Power	1000 W
Door opening	Side opening	Grill element - power	1700 W
Side opening door	Yes	Large grill - Power	2700 W
Removable door	Yes	Grill type	Electric
Full glass inner door	Yes	Tilting grill	Yes

Options Auxiliary Oven

Minimum Temperature	50 °C	Maximum temperature	260 °C
---------------------	-------	---------------------	--------

Third Oven Technical Features



Net volume, 3rd cavity	36 l	Removable inner door	Yes
Gross volume, 3rd cavity	41 l	No. total door glasses	3
Cavity material	Easy clean enamel	No. of thermo-reflective door glasses	1
Shelf positions	2	Safety Thermostat	Yes
Type of shelves	Metal racks	Cooling system	Tangential

No. of lights	1	Usable cavity space dimensions (HxWxD)	169x440x443 mm
Light type	Incandescent	Temperature control	Electro-mechanical
Light power	25 W	Large grill - Power	2700 W
Door opening	Flap down	Grill type	Electric
Removable door	Yes	Tilting grill	Yes
Full glass inner door	Yes		

Options Third Oven

Minimum Temperature	50 °C	Maximum temperature	260 °C
----------------------------	-------	----------------------------	--------

Accessories included for Main Oven & Hob



Rack with back and side stop	2	Grill mesh	1
40mm deep tray	1	Telescopic Guide rails, partial Extraction	1

Accessories included for Secondary Oven



Rack with back and side stop	2	Grill mesh	1
40mm deep tray	1	Telescopic Guide rails, partial Extraction	1

Accessories included for Third Oven

Rack with back and side stop	1	40mm deep tray	1
-------------------------------------	---	-----------------------	---

Electrical Connection

Nominal power	16500 W	Frequency	50 Hz
Current	46 A	Power supply cable length	150 cm
Voltage	220-240 V	Terminal block	5 poles
Voltage 2 (V)	380-415 V		

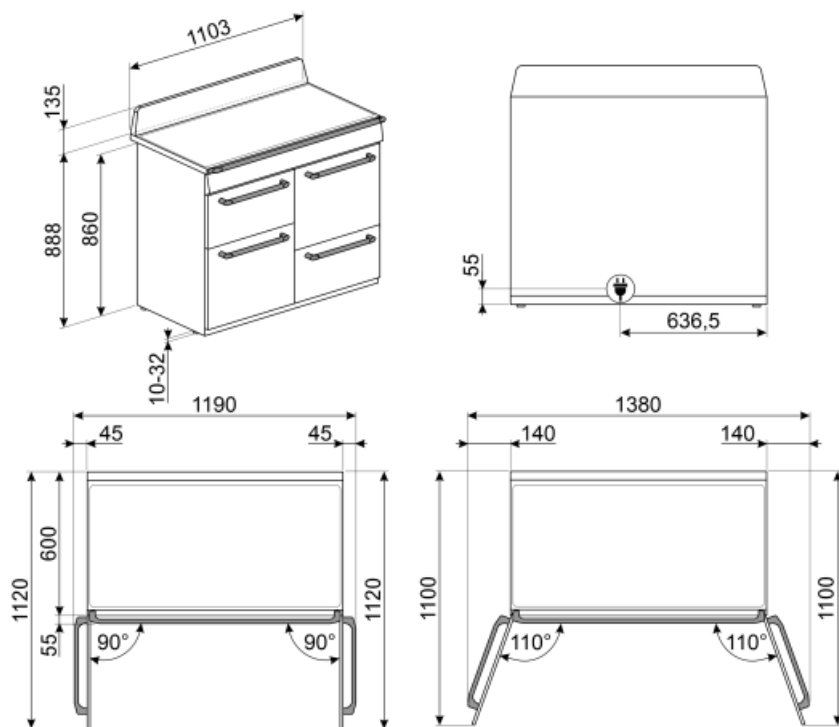

Not included accessories



KITH4110

Height extension kit (950 mm), suitable for TR4110 cookers



SFLK1

Child lock



PRTX

Refractory pizza stone with handles. D=35cm Not suitable for microwave ovens. Suitable for gas ovens, to be put on the griddle.



GRILLPLATE

Universal griddle for induction, gas, ceramic and electric hobs. Non-stick surface ideal for cooking meat, cheese and vegetables. Dimensions: 410 x 240 mm.



BN620-1

Enamelled tray, 20mm deep



SCRP

Induction and ceramic hobs and teppanyaki scraper



KIT600TR4110

Cover strip for hob back side, suitable for TR4110 Victoria cookers



TPKPLATE

Universal plate for induction, gas, ceramic and electric hobs. Non-stick surface ideal for cooking fish, eggs and vegetables. Dimensions: 410 X 240 mm.



AIRFRY

Air fryer rack AIRFRY. Ideal for recreating traditional frying in the oven, but with fewer calories and less fat. It allows you to cook quickly and simply dishes such as French fries, fried vegetables and fish, ensuring perfect browning and crispiness.



GTP

Partially extractable telescopic guides (1 level) Extraction: 300 mm Material: Stainless steel AISI 430 polished



BNP608T

Teflon-coated tray, 8mm depth, to be placed on the grid



KIT1TR41N

Splashback 110x75 cm suitable for TR4110 Victoria cookers, black



KITP65TR41

Depth extension kit (650 mm), suitable for TR4110 cookers



GT1P-2

Partially extractable telescopic guides (1 level) for ovens with metal frames. Length: 355.5 mm, extraction: 285 mm. Material: Stainless steel AISI 430 polished.



BBQ

Double sided plate BBQ. Suitable for recreating succulent and crispy dishes in the oven with the typical taste of grilled cooking. The ribbed side is particularly suitable for meats and cheeses. The smooth side for fish, seafood and vegetables.



KIT1TR41X

Splashback 110x75 cm suitable for TR4110 Victoria cookers, stainless steel

PALPZ



Pizza shovel with fold away handle
width: 315mm length : 325mm

GTT



****Totally extractable telescopic guides (1 level)**** Extraction: 433 mm
Material: Stainless steel AISI 430 polished

BN640







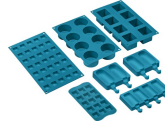













Enamelled tray, 40mm deep











SMOLD



Set of 7 silicone moulds for ice creams, ice lollies, pralines, ice cubes or to portion food. Usable from -60°C to +230°C

Symbols glossary

 <p>Child lock: some models are fitted with a device to lock the programme/cycle so it cannot be accidentally changed.</p>	 <p>Air cooling system: to ensure a safe surface temperatures.</p>
 <p>A: Product drying performance, measured from A+++ to D / G depending on the product family</p>	 <p>Defrost by time: with this function the time of thawing of foods are determined automatically.</p>
 <p>Triple glazed doors: Number of glazed doors.</p>	 <p>ECO-logic: option allows you to restrict the power limit of the appliance real energy saving.</p>
 <p>Enamel interior: The enamel interior of all Smeg ovens have a special antacid lining which helps keep the interior clean by reducing the amount of cooking grease adhering to it.</p>	 <p>Circogas: In gas ovens the fan distributes the heat quickly and evenly throughout the oven cavity, avoiding flavour transfer when cooking a number of different dishes at the same time. In electric ovens this combination completes cooking more quickly of foods that are ready on the surface, but that require more cooking inside, without further browning.</p>
 <p>Fan with upper and lower elements: The elements combined with the fan aim to provide more uniform heat, a similar method to conventional cooking, so pre-heat is required. Most suitable for items requiring slow cooking methods.</p>	 <p>Upper and lower element only: a traditional cooking method best suited for single items located in the centre of the oven. the top pf the oven will always be hottest. Ideal for roast, fruit cakes, bread etc.</p>
 <p>Circulaire: The combination of the fan and circular element around it gives a hot air cooking method. This provides many benefits including no preheat if cook time is more than 20 minutes, no flavour transfer when cooking different foods at the same time, less energy, and shorter cook times. Good for all types of food.</p>	 <p>ECO: The combination of the grill, fan and lower element is particularly suitable for cooking small quantities of food.</p>
 <p>Grill element: Using of grill gives excellent results when cooking meat of medium and small portions, especially when combined with a rotisserie (where possible). Also ideal for cooking sausages and bacon.</p>	 <p>Grill element: Using of grill gives excellent results when cooking meat of medium and small portions, especially when combined with a rotisserie (where possible). Also ideal for cooking sausages and bacon.</p>
 <p>Fan with grill element: The fan reduces the fierce heat from the grill, providing an excellent method of grilling various foods, chops, steaks, sausages etc. giving even browning and heat distribution, without drying out the food. The top two levels recommended for use, and the lower part of the oven can be used to keep items warm at the same time, an excellent facility when cooking a grilled breakfast. Half grill (centre portion only) is ideal for small quantities of food.</p>	 <p>Light</p>
 <p>Overheat protection: The safety system that automatically turns off the hob in case of overheating of the control unit.</p>	 <p>Induction: The work of these hobs is based on the principle of electromagnetic induction. The heat is generated directly in the bottom of the pan during its contact with the hob.</p>

-
- | | | | |
|--|--|---|---|
|  | All glass inner door: All glass inner door, a single flat surface which is simple to keep clean. |  | The inner door glass: can be removed with a few quick movements for cleaning. |
|  | Side lights: Two opposing side lights increase visibility inside the oven. |  | The oven cavity has 2 different cooking levels. |
|  | The oven cavity has 4 different cooking levels. |  | Telescopic rails: allow you to pull out the dish and check it without having to remove it from the oven entirely. |
|  | Electronic control: Allows you to maintain temperature inside the oven with the precision 2-3 ° C. This enables to cook meals that are very sensitive to temperature changes, such as cakes, souffles, puddings. |  | Tilting grill: the tilting grill can be easily unhooked to move the heating element and clean the roof of the appliance in one simple step. |
|  | Vapor Clean: a simple cleaning function using steam to loosen deposits in the oven cavity. |  | The capacity indicates the amount of usable space in the oven cavity in litres. |
|  | The capacity indicates the amount of usable space in the oven cavity in litres. | | |